

Q45VTP and VTPD Wireless Vibration and Temperature Node

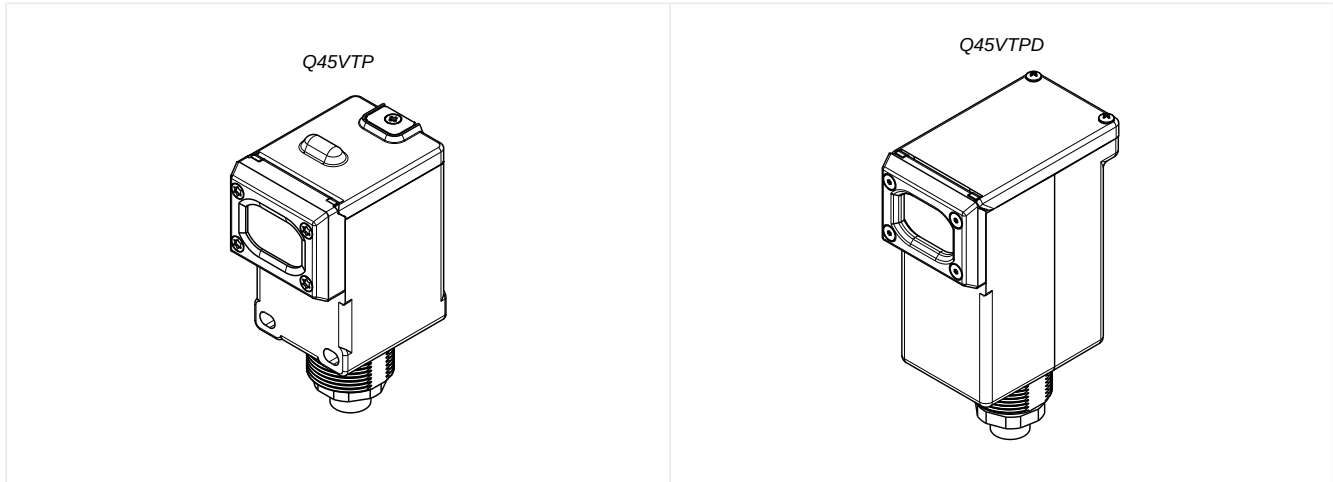

Q45VTP Features

The Wireless Q45VTP Node is a compact, industrial, battery-powered device that wirelessly communicates with any Sure Cross Performance Gateway and mounts on a variety of machines to analyze vibration data and identify and predict failures in rotating machinery. The Q45VTP uses DIP switches to allow multiple configuration options for the vibration characteristics being monitored by Banner's QM30VT1 Vibration Sensor.



Benefits

- Delivers pre-processed high-accuracy vibration values for monitoring rotating equipment such as:
 - Motors
 - Pumps
 - Rotary Compressors
 - Exhaust or HVAC fan motors
 - Spindles
- Easy-to-use rugged device that can be easily mounted to equipment
- Use with the DXM Wireless Controller to track and trend vibration characteristics in real time to predict need for maintenance, predict potential component failure and avoid process downtime.
- **Eliminate control wires**—The Sure Cross wireless system is a radio frequency network with integrated I/O that removes the need for power and control wires
- **Reduce complexity**—Machine or process reconfiguration made easier; great for retrofit applications
- **Deploy easily**—Simplify installation on existing equipment enables deployment in remote and hard-to-access locations where implementing a wired solution would be difficult, impractical, or not cost-effective
- Battery-powered for “peel and stick” functionality with more than 2 years of battery life
- Achieves vibration accuracy of $\pm 10\%$ RMS velocity (in/sec)
- Detects vibration characteristics on 2 axis (radial and axial) such as RMS Velocity, High-Frequency Acceleration, Peak Acceleration, Peak Velocity Component Frequency, etc
- Transmit power levels of 250 mW or 1 Watt for 900 MHz models and 65 mW for 2.4 GHz models are user-selectable
- DIP switches for user configuration of sample time and vibration characteristics
- Frequency Hopping Spread Spectrum (FHSS) technology ensures reliable data delivery
- Transceivers provide bidirectional communication between the Gateway and Node, including fully acknowledged data transmission
- Diagnostics allow user-defined output settings in the unlikely event of a lost radio signal

Q45VTP and VTPD Models

Model	Power	Radio Frequency	Inputs and Outputs
DX80N2Q45VTP	Two AA lithium batteries	2.4 GHz ISM Band	Pre-configured to monitor QM30VT1 vibration/temperature sensors
DX80N9Q45VTP		900 MHz ISM Band	
DX80N2Q45VTPD	One D-cell lithium battery	2.4 GHz ISM Band	
DX80N9Q45VTPD		900 MHz ISM Band	

To order the models without batteries, add an **NB** to the model number. For example, **DX80N2Q45VTPD NB**.

Storage Mode

While in **storage mode**, the device's radio does not operate to conserve the battery. To put any device into storage mode, press and hold the binding button for five seconds. The device is in storage mode when the LEDs stop blinking. To wake the device, press and hold the binding button (inside the housing on the radio board) for five seconds.

General Operation

For the first 15 minutes after power up, the Node samples the sensor every two seconds (fast sample mode). After 15 minutes, the Node defaults to five-minute sample intervals. Activate fast sample mode by single-clicking the button (the amber LED is solid).

ISO 10816 provides guidance for evaluating vibration velocity severity motors, pumps, fans, compressors, gearboxes, blowers, dryers, presses, and other machines that operate in the 10 to 1000 Hz frequency range.

Vibration Severity per ISO 10816

Vibration Velocity Vrms	Machine		Class I	Class II	Class III	Class IV
	in/s	mm/s	Small Machines	Medium Machines	Large Rigid Foundation	Large Soft Foundation
0.01	0.28					
0.02	0.45					
0.03	0.71			good		
0.04	1.12					
0.07	1.80					
0.11	2.80			satisfactory		
0.18	4.50					
0.28	7.10			unsatisfactory		
0.44	11.2					
0.70	18.0					
1.10	28.0			unacceptable		
1.77	45.9					

Button and LEDs

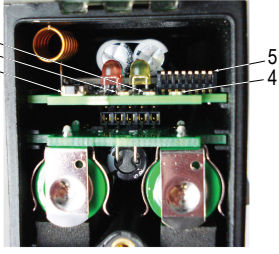

1	Button
2	Red LED (flashing) indicates a radio link error with the Gateway.
3	Green LED (flashing) indicates a good radio link with the Gateway.
4	Amber LED is not used.
5	DIP Switches

Configuration Instructions

Q45VTP and VTPD DIP Switches

After making any changes to any DIP switch position, reboot the Q45VTP by triple-clicking the button, waiting a second, then double-clicking the button.

The DIP switches are in the OFF position. To turn a DIP switch on, push the switch toward the battery pack. DIP switches one through four are numbered from left to right.

Description	DIP Switches							
	1	2	3	4	5	6	7	8
Transmit power: 1 Watt (default)	OFF							

Continued on page 3

Continued from page 2

Description	DIP Switches							
	1	2	3	4	5	6	7	8
Transmitt power: 250 mW (compatible with 150 mW radios)	ON							
Default I/O configuration ⁽¹⁾ (default)		OFF	OFF	OFF				
I/O configuration 1		OFF	OFF	ON				
I/O configuration 2		OFF	ON	OFF				
I/O configuration 3		OFF	ON	ON				
I/O configuration 4		ON	OFF	OFF				
I/O configuration 5		ON	OFF	ON				
Reserved		ON	ON	OFF				
User configured (use the Sensor Configuration Software to pre-configure QM30VT1)		ON	ON	ON				
Sample/report rate: user configured (5 minutes by default)					OFF	OFF		
Sample/report rate: 150 seconds					OFF	ON		
Sample/report rate: 60 seconds					ON	OFF		
Reserved					ON	ON		
U.S. Standard units (e.g. velocity = in/s) (default)							OFF	
Metric units (e.g. velocity = mm/s)							ON	
Reserved (default)								OFF

Input Register		Default I/O	I/O Configuration 1	I/O Configuration 2	I/O Configuration 3	I/O Configuration 4	I/O Configuration 5
1	Z-Axis	RMS Velocity (in/s)	RMS Velocity (in/s)	High-Frequency RMS Acceleration (G)	RMS Velocity (in/s)	Full Bandwidth RMS Acceleration (G)	RMS Velocity (in/s)
2		High-Frequency RMS Acceleration (G)	Peak Acceleration (G)	Peak Acceleration (G)	Peak Velocity Component Frequency (Hz)	Full Bandwidth Peak Acceleration (G)	Full Bandwidth RMS Acceleration (G)
3	-	Temperature (°F)	Temperature (°F)	Temperature (°F)	Temperature (°F)	Temperature (°F)	Temperature (°F)
4	-	Reserved	Reserved	Reserved	Reserved	Reserved	Reserved
5	X-Axis	RMS Velocity (in/s)	RMS Velocity (in/s)	High-Frequency RMS Acceleration (G)	RMS Velocity (in/s)	Full Bandwidth RMS Acceleration (G)	RMS Velocity (in/s)
6		High-Frequency RMS Acceleration (G)	Peak Acceleration (G)	Peak Acceleration (G)	Peak Velocity Component Frequency (Hz)	Full Bandwidth Peak Acceleration (G)	Full Bandwidth RMS Acceleration (G)

If DIP switch 7 is on, all in/s units change to mm/s. DIP switch 7 will only switch units with DIP switch I/O configurations, not with any user configuration.

Apply Power to the Q45 AA-Cell Models

Follow these instructions to install or replace the lithium "AA" cell batteries.

CAUTION:



- **As with all batteries, these are fire, explosion, and severe burn hazards. There is a risk of explosion if the battery is replaced incorrectly.**
- Do not burn or expose them to high temperatures. Do not recharge, crush, disassemble, or expose the contents to water.
- Verify the battery's positive and negative terminals align to the positive and negative terminals of the battery holder mounted within the case.
- Properly dispose of used batteries according to local regulations by taking them to a hazardous waste collection site, an e-waste disposal center, or another facility qualified to accept lithium batteries.

⁽¹⁾ User configurable if switch 7 is OFF; for input serial addresses, see ["Modbus Registers and IO Serial Addresses"](#) on page 5

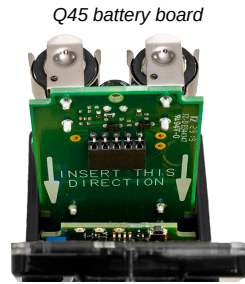

1. Loosen the clamp plate with a small Phillips screwdriver and lift the cover.
2. Slide the battery board out of the Q45 housing.
3. If applicable, remove the discharged batteries.
4. Install the new batteries.
Use Banner's **BWA-BATT-006** replacement batteries or equivalent 3.6 V AA lithium batteries, such as Xeno's XL-60F.
5. Verify the battery's positive and negative terminals align to the positive and negative terminals of the battery holder mounted within the case.
6. Slide the board containing the new batteries back into the Q45 housing.
7. Close the cover and gently tighten the clamp plate with the small Phillips screwdriver.

Apply Power to the Q45 D-Cell Models

Follow these instructions to install or replace the lithium D-cell batteries.

CAUTION:



- As with all batteries, these are fire, explosion, and severe burn hazards. There is a risk of explosion if the battery is replaced incorrectly.
- Do not burn or expose them to high temperatures. Do not recharge, crush, disassemble, or expose the contents to water.
- Verify the battery's positive and negative terminals align to the positive and negative terminals of the battery holder mounted within the case.
- Properly dispose of used batteries according to local regulations by taking them to a hazardous waste collection site, an e-waste disposal center, or another facility qualified to accept lithium batteries.



1. Loosen the clamp plate with a small Phillips screwdriver and lift the cover.
2. Use the black pull wire to pull the battery board out of the Q45 housing.
3. If applicable, remove the discharged battery.
4. Install the new battery. Use Banner's **BWA-BATT-011** replacement battery or an equivalent 3.6 V D-cell lithium battery, such as Xeno's XL-205F.
5. Verify the battery's positive and negative terminals align to the positive and negative terminals of the battery holder mounted within the case.
6. Slide the board containing the new battery back into the Q45 housing.
7. Close the cover and gently tighten the clamp plate with the small Phillips screwdriver.

Bind to the Gateway and Assign the Node Address

Before beginning the binding procedure, apply power to all the devices. Separate the devices by two meters when running the binding procedure. Put only one Gateway into binding at a time to prevent binding to the wrong Gateway.

1. On the Gateway: Enter binding mode.

- For housed DX80 Gateways, triple-click button 2 on the Gateway. Both LEDs flash red.
 - For Gateway board modules, triple-click the button. The green and red LED flashes.
2. Assign the Q45VTP a Node address using the Gateway's rotary dials. Use the left rotary dial for the left digit and the right rotary dial for the right digit. For example, to assign your Q45VTP to Node 10, set the Gateway's left dial to 1 and the right dial to 0. Valid Node addresses are 01 through 47.
 3. On the Q45: Loosen the clamp plate on the top of the Q45VTP and lift the cover.
 4. Enter binding mode on the Q45VTP by triple-clicking the Q45VTP's button.
The red and green LEDs flash alternately and the sensor searches for a Gateway in binding mode. After the Q45VTP is bound, the LEDs stay solid momentarily, then they flash together four times. The Q45VTP exits binding mode.
 5. Label the sensor with the Q45VTP's Node address number for future reference.
 6. Repeat steps 2 through 5 for as many Q45VTPs as are needed for your network.
 7. On the Gateway: After binding all Q45VTPs, exit binding mode.
 - For housed DX80 Gateways, double-click button 2.
 - For board-level DX80 Gateways, double-click the button.

For Gateways with single-line LCDs: After binding your Q45VTP to the Gateway, make note of the binding code displayed under the Gateway's *DVCFG menu, XADR submenu on the LCD. Knowing the binding code prevents having to re-bind all Q45VTPs if your Gateway is ever replaced.

Bind to a DXM and Assign the Node Address

Before beginning the binding procedure, apply power to all the devices. Separate the radios by two meters when running the binding procedure. Put only one DXM into binding mode at a time to prevent the Q45VTP from binding to the wrong Gateway.

1. On the DXM: Use the arrow keys to select the **ISM Radio** menu on the LCD and click **ENTER**.
2. Highlight the **Binding** menu and click **ENTER**.
3. Use the arrow keys to select the Node address to bind the Q45VTP to.
4. On the Q45VTP: Loosen the top clamp plate and lift the cover.
5. Enter binding mode by triple-clicking the binding button.
The red and green LEDs flash alternately and the sensor searches for a Gateway in binding mode. After the Node binds, the LEDs stay solid momentarily, then they flash together four times. The Node exits binding mode.
6. Label the sensor with the Node address number for future reference.
7. On the DXM: Click **BACK** to exit binding for that specific Node address.
8. Repeat steps 3 through 7 and change the Node address for as many Q45VTPs as are needed for your network.
9. On the DXM: After you have finished forming your network, click **BACK** until you reach the main menu.

Modbus Registers and IO Serial Addresses

I/O serial addresses

Serial Address	Output Type	I/O Range		Holding Register Representation	
		Min	Max	Min (Dec)	Max (Dec)
16	Z-Axis RMS Velocity (in/sec) ^{1, 5}	0	6.5535	0	65535
25	Z-Axis High-Frequency RMS Acceleration ^{2, 6}	0	65.535	0	65535
-	Reserved	-	-	-	-
64	X-Axis RMS Velocity (in/sec) ^{1, 5}	0	6.5535	0	65535
73	X-Axis High-Frequency RMS Acceleration (G) ^{2, 6}	0	65.535	0	65535
20	Z-Axis Peak Acceleration (G) ^{2, 6}	0	65.535	0	65535
68	X-Axis Peak Acceleration (G) ^{2, 6}	0	65.535	0	65535
18	Z-Axis Peak Velocity Component Frequency (Hz) ^{4, 5}	0	6553.5	0	65535
66	X-Axis Peak Velocity Component Frequency (Hz) ^{4, 5}	0	6553.5	0	65535
19	Z-Axis RMS Acceleration (G) ^{2, 5}	0	65.535	0	65535
67	X-Axis RMS Acceleration (G) ^{2, 5}	0	65.535	0	65535
24	Z-Axis Kurtosis ^{2, 6}	0	65.535	0	65535
72	X-Axis Kurtosis ^{2, 6}	0	65.535	0	65535
37	Z-Axis Crest Factor ^{2, 6}	0	65.535	0	65535

Continued on page 6

Continued from page 5

Serial Address	Output Type	I/O Range		Holding Register Representation	
		Min	Max	Min (Dec)	Max (Dec)
69	X-Axis Crest Factor ^{2, 6}	0	65.535	0	65535
17	Z-Axis Peak Velocity (in/sec) ^{1, 5}	0	6.5535	0	65535
23	Z-Axis Peak Velocity (mm/sec) ^{2, 5}	0	65.535	0	65535
65	X-Axis Peak Velocity (in/sec) ^{1, 5}	0	6.5535	0	65535
71	X-Axis Peak Velocity (mm/sec) ^{2, 5}	0	65.535	0	65535
22	Z-Axis RMS Velocity (mm/sec) ^{2, 5}	0	65.535	0	65535
70	X-Axis RMS Velocity (mm/sec) ^{2, 5}	0	65.535	0	65535
27	Full Bandwidth RMS Acceleration Z-Axis (G) ^{2, 7}	0	65.535	0	65535
75	Full Bandwidth RMS Acceleration X-Axis (G) ^{2, 7}	0	65.535	0	65535
28	Full Bandwidth Peak Acceleration Z-Axis (G) ^{2, 7}	0	65.535	0	65535
76	Full Bandwidth Peak Acceleration X-Axis (G) ^{2, 7}	0	65.535	0	65535
192	Temperature (°C) ³	-1638.4	1638.4	-32768	32767
193	Temperature (°F) ³	-1638.4	1638.4	-32768	32767

¹ Value = Register value ÷ 10000

² Value = Register value ÷ 1000

³ Value = Register value ÷ 20

⁴ Value = Register value ÷ 10

⁵ Measurement bandwidth = 10 Hz to 1 kHz

⁶ Measurement bandwidth = 1 kHz to 4 kHz

⁷ Measurement Bandwidth = 10 Hz to 4 kHz

Modbus holding registers

I/O #	Modbus Holding Register		I/O Type	I/O Range		Holding Register Representation	
	Gateway	Any Node		Min.	Max.	Min.	Max.
1	1	1 + (Node# × 16)	Sensor Input Register 1				
2	2	2 + (Node# × 16)	Sensor Input Register 2				
3	3	3 + (Node# × 16)	Sensor Input Register 3				
4	4	4 + (Node# × 16)	Sensor Input Register 4				
5	5	5 + (Node# × 16)	Sensor Input Register 5				
6	6	6 + (Node# × 16)	Sensor Input Register 6				
7	7	7 + (Node# × 16)	Reserved				
8	8	8 + (Node# × 16)	Device Message				
		...					
15	15	15 + (Node# × 16)	Control Message				
16	16	16 + (Node# × 16)	Reserved				

By default, data is supplied to the Node every five minutes, unless the Node requests the data sooner. The default configuration is shown and all optional outputs types are listed. Use the User Configuration Software to adjust the Sensor Register output type. Temperature values outside the operating range of the device are forced to the maximum or minimum values.

Specifications

Radio Specifications for Performance with Internal Antenna

Supplied Antenna

This device includes an internal 2 dB antenna. Range depends on the environment and decreases significantly without line-of-sight. Always verify your wireless network's range by performing a Site Survey.

Radio Transmit Power (900 MHz, 1 Watt radios)

Conducted: 30 dBm (1 W)

EIRP with the supplied 2 dB antenna: < 36 dBm

Radio Transmit Power (2.4 GHz radios)

Conducted: < 18 dBm (65 mW)

EIRP with the supplied 2 dB antenna: < 20 dBm (100 mW)

Antenna Minimum Separation Distance

900 MHz (1 Watt): 4.57 m (15 ft) with the supplied 2 dB antenna

2.4 GHz (65 mW): 0.3 m (1 ft) with the supplied 2 dB antenna

Radio Range

900 MHz (in 1 Watt mode): Up to 3.2 km (2 miles) with line of sight (internal antenna)

2.4 GHz: Up to 1000 m (3280 ft) with line of sight (internal antenna)

Link Timeout (Performance)

Gateway: Configurable via User Configuration Software

Node: Defined by Gateway

Spread Spectrum Technology

FHSS (Frequency Hopping Spread Spectrum)

900 MHz Compliance (SX7023EXT Radio Module)

Radio module is indicated by the product label marking

Contains FCC ID: UE3SX7023EXT: FCC Part 15, Subpart C, 15.247

Contains IC: 7044A-SX7023EXT

900 MHz Compliance (RM1809 Radio Module)

Radio module is indicated by the product label marking
Contains FCC ID: UE3RM1809: FCC Part 15, Subpart C, 15.247

Contains IC: 7044A-RM1809

IFT: RCPBARM13-2283



2.4 GHz Compliance (DX80-2400 Radio Module)

Radio module is indicated by the product label marking
Contains FCC ID: UE300DX80-2400: FCC Part 15, Subpart C, 15.247

Radio Equipment Directive (RED) 2014/53/EU

Contains IC: 7044A-DX8024

ANATEL: 15966-21-04042



2.4 GHz Compliance (SX243 Radio Module)

Radio module is indicated by the product label marking
Contains FCC ID: UE3SX243: FCC Part 15, Subpart C, 15.247

Radio Equipment Directive (RED) 2014/53/EU

ETSI/EN: EN 300 328 V2.2.2 (2019-07) [RED HarmStds]

Contains IC: 7044A-SX243

ANATEL: 03737-22-04042



Environmental Specifications for the Q45

Operating Conditions

-40 °C to +70 °C (-40 °F to +158 °F); 90% at +50 °C maximum relative humidity (non-condensing)

Radiated Immunity: 10 V/m (EN 61000-4-3)

Environmental Rating

NEMA 6P

IP67

Operating the devices at the maximum operating conditions for extended periods can shorten the life of the device.

Q45VTP and VTPD Specifications

Typical Battery Life

See chart

Default Sensing Interval

5 minutes

Shock

400G

Certifications



Banner Engineering BV
Park Lane, Culliganlaan 2F bus 3
1831 Diegem, BELGIUM

Construction

Molded reinforced thermoplastic polyester housing, oring-sealed transparent Lexan® cover, molded acrylic lenses, and stainless steel hardware. Designed to withstand 1200 psi washdown.

Indicators

Red and green LEDs (radio function)



Turck Banner LTD Blenheim House
Blenheim Court
Wickford, Essex SS11 8YT
GREAT BRITAIN

(CE/UKCA approval only applies to 2.4 GHz models)

Q45VTP and VTPD Battery Life

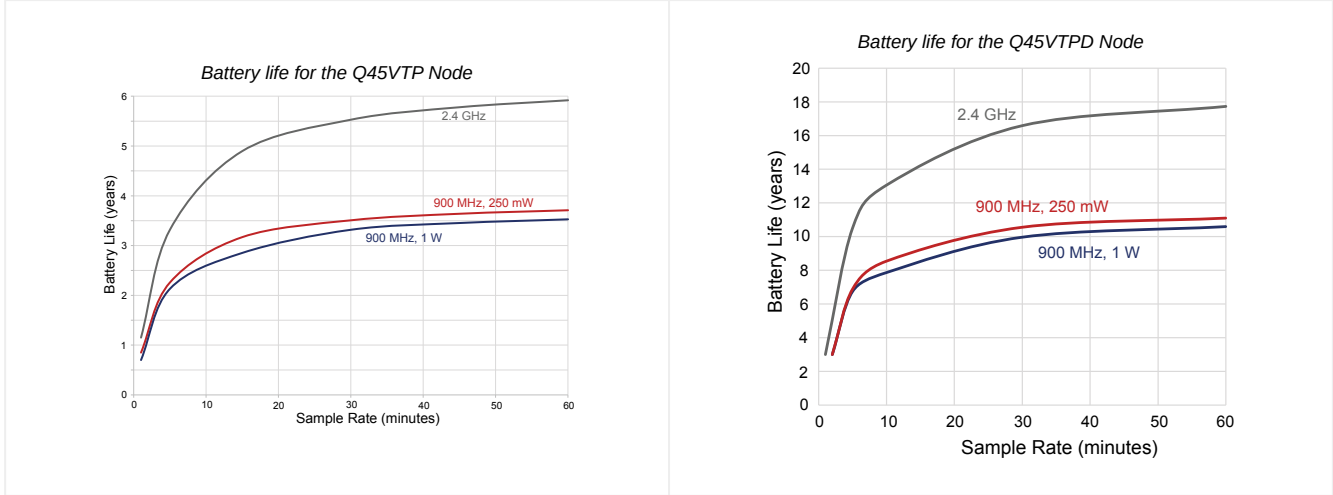

FCC Part 15 Class A for Intentional Radiators

This equipment has been tested and found to comply with the limits for a Class A digital device, pursuant to part 15 of the FCC Rules. These limits are designed to provide reasonable protection against harmful interference when the equipment is operated in a commercial environment. This equipment generates, uses, and can radiate radio frequency energy and, if not installed and used in accordance with the instruction manual, may cause harmful interference to radio communications. Operation of this equipment in a residential area is likely to cause harmful interference in which case the user will be required to correct the interference at his own expense.

Industry Canada Statement for Intentional Radiators



This device contains licence-exempt transmitters(s)/receiver(s) that comply with Innovation, Science and Economic Development Canada's licence-exempt RSS(s). Operation is subject to the following two conditions:

1. This device may not cause interference.
2. This device must accept any interference, including interference that may cause undesired operation of the device.

Cet appareil contient des émetteurs/récepteurs exemptés de licence conformes à la norme Innovation, Sciences, et Développement économique Canada. L'exploitation est autorisée aux deux conditions suivantes:

1. L'appareil ne doit pas produire de brouillage.
2. L'utilisateur de l'appareil doit accepter tout brouillage radioélectrique subi, même si le brouillage est susceptible d'en compromettre le fonctionnement.

Q45VTP and VTPD Accessories

<p>BWA-BATT-006</p> <ul style="list-style-type: none"> • 3.6 V Lithium AA cell • Two batteries 	
<p>BWA-BATT-011</p> <ul style="list-style-type: none"> • 3.6 V Lithium D cell for non-hazardous locations only • 19000 mAh • One battery 	

QM30VT1 Vibration and Temperature Sensor

- Aluminum housing
- 2.09 m (6.85 ft) cable with a 5-pin M12 male quick disconnect (QD)
- Datasheet: [212568](#)

QM30VT1-QP Vibration and Temperature Sensor

- Aluminum housing
- 150 mm (6 in) cable with a 5-pin M12 male quick disconnect (QD)
- Datasheet: [212568](#)

QM30VT1-SS Vibration and Temperature Sensor

- Stainless steel housing
- 2.09 m (6.85 ft) cable with a 5-pin M12 male quick disconnect (QD)
- Datasheet: [212568](#)

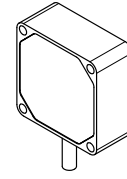

Warnings

Exporting Sure Cross® Radios. It is our intent to fully comply with all national and regional regulations regarding radio frequency emissions. **Customers who want to re-export this product to a country other than that to which it was sold must ensure the device is approved in the destination country.** The Sure Cross wireless products were certified for use in these countries using the antenna that ships with the product. When using other antennas, verify you are not exceeding the transmit power levels allowed by local governing agencies. This device has been designed to operate with the antennas listed on Banner Engineering's website and having a maximum gain of 9 dBm. Antennas not included in this list or having a gain greater than 9 dBm are strictly prohibited for use with this device. The required antenna impedance is 50 ohms. To reduce potential radio interference to other users, the antenna type and its gain should be so chosen such that the equivalent isotropically radiated power (EIRP) is not more than that permitted for successful communication. Consult with Banner Engineering Corp. if the destination country is not on this list.

IMPORTANT: Please download the complete Wireless Q45VTP Node technical documentation, available in multiple languages, from www.bannerengineering.com for details on the proper use, applications, Warnings, and installation instructions of this device.

IMPORTANT: Por favor descargue desde www.bannerengineering.com toda la documentación técnica de los Wireless Q45VTP Node, disponibles en múltiples idiomas, para detalles del uso adecuado, aplicaciones, advertencias, y las instrucciones de instalación de estos dispositivos.

IMPORTANT: Veuillez télécharger la documentation technique complète des Wireless Q45VTP Node sur notre site www.bannerengineering.com pour les détails sur leur utilisation correcte, les applications, les notes de sécurité et les instructions de montage.

WARNING:

- **Do not use this device for personnel protection**
- Using this device for personnel protection could result in serious injury or death.
- This device does not include the self-checking redundant circuitry necessary to allow its use in personnel safety applications. A device failure or malfunction can cause either an energized (on) or de-energized (off) output condition.

IMPORTANT:

- **Electrostatic discharge (ESD) sensitive device**
- ESD can damage the device. Damage from inappropriate handling is not covered by warranty.
- Use proper handling procedures to prevent ESD damage. Proper handling procedures include leaving devices in their anti-static packaging until ready for use; wearing anti-static wrist straps; and assembling units on a grounded, static-dissipative surface.

Banner Engineering Corp Limited Warranty

Banner Engineering Corp. warrants its products to be free from defects in material and workmanship for one year following the date of shipment. Banner Engineering Corp. will repair or replace, free of charge, any product of its manufacture which, at the time it is returned to the factory, is found to have been defective during the warranty period. This warranty does not cover damage or liability for misuse, abuse, or the improper application or installation of the Banner product.

THIS LIMITED WARRANTY IS EXCLUSIVE AND IN LIEU OF ALL OTHER WARRANTIES WHETHER EXPRESS OR IMPLIED (INCLUDING, WITHOUT LIMITATION, ANY WARRANTY OF MERCHANTABILITY OR FITNESS FOR A PARTICULAR PURPOSE), AND WHETHER ARISING UNDER COURSE OF PERFORMANCE, COURSE OF DEALING OR TRADE USAGE.

This Warranty is exclusive and limited to repair or, at the discretion of Banner Engineering Corp., replacement. **IN NO EVENT SHALL BANNER ENGINEERING CORP. BE LIABLE TO BUYER OR ANY OTHER PERSON OR ENTITY FOR ANY EXTRA COSTS, EXPENSES, LOSSES, LOSS OF PROFITS, OR ANY INCIDENTAL, CONSEQUENTIAL OR SPECIAL DAMAGES RESULTING FROM ANY PRODUCT**